

Fittings

When Ordering,
Please Specify
Type of Material:

- Carbon
- Stainless
- Aluminum
- Galvanized Steel

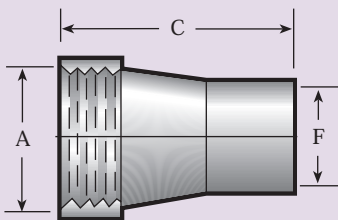

Female Adapter

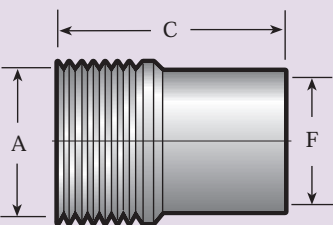

Male Adapter

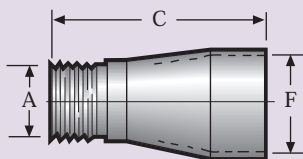

Male Adapter

Standard Adapters

Female and Male Adapters

- 2" to 12"
- Wall Thickness: 16, 14, 12, 11 Gauge
- Materials: Carbon, Stainless, Aluminum, Galvanized Steel

Female Adapters

• 11 GAUGE AVAILABLE

SIZE	GAUGE	A-FNPT	C	F (OD)	PART NO.
2" to 2"	16	2"	6"	2"	FA-201
2" to 2-1/8"	16	2"	6"	2-1/8"	FA-211
2-1/2" to 2-1/2"	16	2-1/2"	6"	2-1/2"	FA-251
3" to 3"	16	3"	6"	3"	FA-301
3-1/2" to 3-1/2"	16	3-1/2"	6"	3-1/2"	FA-351
4" to 4"	16	4"	6-1/2"	4"	FA-401
5" to 5"	14	5"	6-3/4"	5"	FA-501
6" to 6"	14	6"	7"	6"	FA-601
8" to 8"	14	8"	9"	8"	FA-801
10" to 10"	12	10"	11"	10"	FA-1001
12" to 12"	12	12"	13"	12"	FA-1201

Male Adapters

• 11 GAUGE AVAILABLE

SIZE	GAUGE	A-MNPT	C	F (OD)	PART NO.
2" to 2"	16	2"	6"	2"	MA-202
2" to 2-1/8"	16	2"	6"	2-1/8"	MA-212
2-1/2" to 2-1/2"	16	2-1/2"	6"	2-1/2"	MA-252
3" to 3"	16	3"	6"	3"	MA-302
3-1/2" to 3-1/2"	16	3-1/2"	6"	3-1/2"	MA-352
4" to 4"	16	4"	6"	4"	MA-402
5" to 5"	14	5"	6-1/2"	5"	MA-502
6" to 6"	14	6"	7"	6"	MA-602
8" to 8"	14	8"	8"	8"	MA-802
10" to 10"	12	10"	8-1/2"	10"	MA-1002
12" to 12"	12	12"	9"	12"	MA-1202

Male Adapters

- 2-1/8"
- Materials: Carbon, Stainless, Aluminum, Galvanized Steel

SIZE	A-MNPT	C	D	F (ID)	F (OD)	PART NO.
2-1/8" x 1-1/4"	1-1/4"	5-3/4"	-	-	2-1/8"	MA-16
2-1/8" x 1-1/2"	1-1/2"	5-3/4"	-	-	2-1/8"	MA-17
2-1/8" x 1-1/4"	1-1/4"	5-3/4"	1-1/4"*	2-1/8"	-	MA-18
2-1/8" x 1-1/2"	1-1/2"	5-3/4"	1-1/4"*	2-1/8"	-	MA-19

* EXPANSION DEPTH

KEY
 FNPT = Female National Pipe Thread
 OD = Outside Diameter
 MNPT = Male National Pipe Thread
 ID = Inside Diameter
 All reference dimensions are nominal.

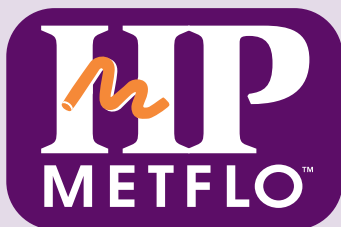

When Ordering,
Please Specify
Type of Material:

- Carbon
- Stainless
- Aluminum
- Galvanized Steel

Standard Adapters - cont.

Female and Male Adapter Expanded

- 2" to 6"
- Wall Thickness: 16, 14, 12 Gauge
- Materials: Carbon, Stainless, Aluminum, Galvanized Steel

Female Adapter Expanded

SIZE	GAUGE	A-FNPT	C	D	E (ID)	PART NO.
2" to 2"	16	2"	4"	1-1/8"	2"	FA-203
2" to 2-1/8"	16	2"	6"	1-3/8"	2-1/8"	FA-213
2-1/2" to 2-1/2"	16	2-1/2"	5"	1-3/8"	2-1/2"	FA-253
3" to 3"	16	3"	5-1/4"	1-3/8"	3"	FA-303
3-1/2" to 3-1/2"	16	3-1/2"	5-1/2"	1-3/8"	3-1/2"	FA-353
4" to 4"	16	4"	6-1/2"	1-3/8"	4"	FA-403
5" to 5"	14	5"	6-3/4"	1-5/8"	5"	FA-503
6" to 6"	14	6"	7"	1-5/8"	6"	FA-603

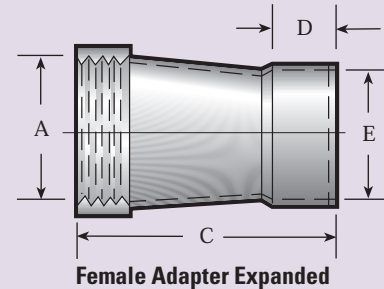

Female Adapter Expanded

Male Adapter Expanded

SIZE	GAUGE	A-MNPT	C	D	E (ID)	PART NO.
2" to 2"	16	2"	4"	1-1/8"	2"	MA-204
2" to 2-1/8"	16	2"	4"	1-3/8"	2-1/8"	MA-214
2-1/2" to 2-1/2"	16	2-1/2"	4"	1-3/8"	2-1/2"	MA-254
3" to 3"	16	3"	4-3/4"	1-3/8"	3"	MA-304
3-1/2" to 3-1/2"	16	3-1/2"	4-3/4"	1-3/8"	3-1/2"	MA-354
4" to 4"	16	4"	4-3/4"	1-3/8"	4"	MA-404
5" to 5"	14	5"	5"	1-5/8"	5"	MA-504
6" to 6"	14	6"	5-1/4"	1-5/8"	6"	MA-604

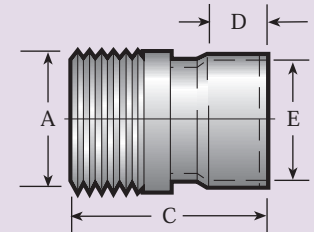

Male Adapter Expanded

90° Adapter Elbow

- 2-1/8" to 2"
- Available only in Cast Gray Iron, Zinc, Nickel Plated or Cast Aluminum

SIZE	C	D	E (ID)	H	L-FNPT	PART NO.
2-1/8" to 2"	2-9/16"	1-3/8"	2-1/8"	1-5/8"	2"	AE-211*

* AVAILABLE ONLY IN CAST GRAY IRON, ZINC, NICKEL PLATED OR CAST ALUMINUM

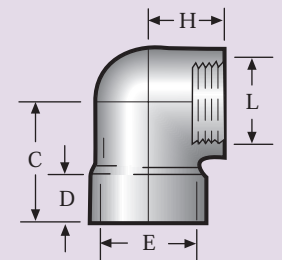

90° Adapter Elbow

Adapter Tees

- 2-1/8" to 4"

• 11 GAUGE ADAPTERS AVAILABLE

SIZE	C	D	E (ID)	H	L-FNPT	PART NO.
2-1/8" to 2"	4-13/16"	1-3/8"	2-1/8"	1-9/16"	2"	AT-212*
2-1/2" to 2"	6-1/2"	1-3/8"	2-1/2"	2-1/8"	2"	AT-250
3" to 2"	6-1/2"	1-3/8"	3"	2-3/4"	2"	AT-302
3-1/2" to 2"	6-7/8"	1-3/8"	3-1/2"	3-7/16"	2"	AT-352
4" to 2"	6-7/8"	1-3/8"	4"	3-7/16"	2"	AT-402

* AVAILABLE ONLY IN CAST GRAY IRON, ZINC, NICKEL PLATED OR CAST ALUMINUM & NOT 11 GAUGE

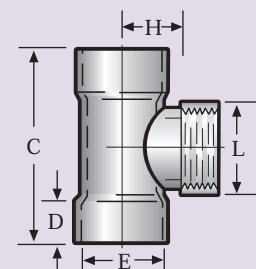

Adapter Tee

KEY

FNPT = Female National Pipe Thread
ID = Inside Diameter
MNPT = Male National Pipe Thread
All reference dimensions are nominal.



Fittings

When Ordering,
Please Specify
Type of Material:

- Carbon
- Stainless
- Aluminum
- Galvanized Steel

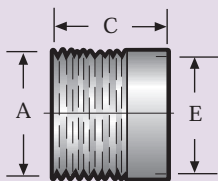

Male Adapter Nipple

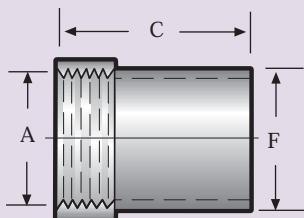

Female Reducing Adapter

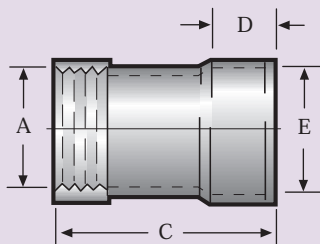

Female Reducing Adapter Expanded

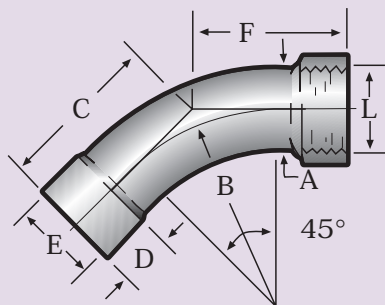

45° Female Adapter Elbow

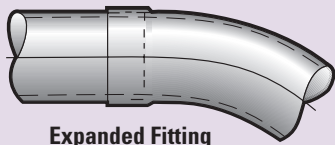

Expanded Fitting



Standard Adapters - cont.

Male Adapter Nipple

- 2-1/8"
- Materials: Carbon, Stainless, Aluminum, Galvanized Steel

SIZE	A-MNPT	C	E (ID)	PART NO.
2-1/8"	2"	2"	2-1/8"	MA-20

Female Reducing Adapter

- 2" to 2-1/2"
- Wall Thickness: 16 Gauge
- Materials: Carbon, Stainless, Aluminum, Galvanized Steel

SIZE	GAUGE	A-FNPT	C	F (OD)	PART NO.
2" to 2-1/2"	16	2"	4-1/4"	2-1/2"	FA-205

Female Reducing Adapter Expanded

- 2" to 2-1/2"
- Wall Thickness: 16 Gauge

SIZE	GAUGE	A-FNPT	C	D	E (ID)	PART NO.
2" to 2-1/2"	16	2"	4-1/4"	1-3/8"	2-1/2"	FA-206

45° Female Adapter Elbow

- 2-1/8" to 2-1/2" OD
- Wall Thickness: 16, (11 Gauge Available in Straight Ends Only)
- Materials: Carbon, Stainless, Aluminum, Galvanized Steel

SIZE	A (OD)	GAUGE	B	C	D	E (ID)	L-FNPT	PART NO.
2-1/8" to 2"	2-1/8"	16	5"	4-1/16"	1-3/8"	2-1/8"	2"	AE-2111
2-1/2" to 2"	2-1/2"	16	6"	4-1/2"	1-3/8"	2-1/2"	2"	AE-2511
2-1/2" to 2-1/2"	2-1/2"	16	6"	4-1/2"	1-3/8"	2-1/2"	2-1/2"	AE-2512

Expanded Fittings

This type of connection enables a straight section of tubing to slip inside the expanded end of the fitting. The two pieces can then be "locked" together by any one of several techniques - brazing, welding, industrial adhesive or shrink sleeve. Not available in 11 gauge material. Joining methods are for use in low pressure (under 15 PSIG) systems. Slotted joining method also available.

KEY

MNPT = Male National Pipe Thread
ID = Inside Diameter
FNPT = Female National Pipe Thread
OD = Outside Diameter
All reference dimensions are nominal.