

Installation Components

Bold Type Designates a Stock Item

Order by Product ID Number

H-P Products, Inc. gives you everything you need to get your system up and running, all in one complete installation package. If you're searching for a particular installation component, we'll be glad to help you find whatever you're looking for. Our "one-stop-shopping" will help you lower your inventory costs and spend less time looking for parts. And, when it's time for installation, you'll have all the components you need on-the-spot.

DESCRIPTION	SIZE	MATERIAL	PKGD.	PRODUCT ID
Anchor	3/8" x 1-9/16" (Length)	Zinc	50 pc.	ANC-0380
Bolt Anchor Includes Washer and Hex Nut	3/8" x 3-3/4" (Overall Length) 1-1/8" Thread Length	Zinc	100 pc.	ANC-0381
Features: Comprehensive performance testing in concrete, lightweight concrete, and grout-filled block base materials. Can be installed in a bottomless hole. Anchor size is same as hole size for easy installation. Hilti® Kwik Bolt II Stud Anchor System.				
Hex Head Cap Screw	3/8" x 1" (Length)	Zinc	50 pc.	HCS-0380
Hex Head Cap Screw "More Length When You Need It"	3/8" x 1-1/4" (Length)	Zinc	50 pc.	HCS-0381
Hex Nut	3/8"	Zinc	50 pc.	HXN-0380
Flat Washer	3/8"	Zinc	50 pc.	FW-0380
Split Lock Washer	3/8"	Zinc	50 pc.	LKW-0380
Threaded Rod	3/8" x 6' (Length)	Zinc	each	ATR-100
Eye Nut , Maximum Allowable Load is 610 lbs. "Works Great With MetFlo™ Tube Hangers"	3/8" Tapped Hole	Malleable Iron - Plain.	each	EN-0380
Coupler Nut	3/8" x 1-3/4" (Length)	Zinc	each	CN-0380
Beam Clamp with Zinc Set Screw and Lock Nut. Maximum Allowable Load, in top or bottom position, is 550 lbs.	3/8" Tapped Hole	Malleable Iron - Galv.	each	BC-037T
Beam Clamp with Set Screw and Lock Nut. Maximum Allowable Load, in top position, is 500 lbs.; in bottom position, 250 lbs. "The Cost-Effective Solution When You Don't Need Our Heavy-Duty Beam Clamp (BC-037T)"	3/8" Tapped Hole	Malleable Iron - Plain	each	BC-100
Beam Clamp with U-Bolt and 3/8" Hex Nuts included, for use with Beams up to 3/4" Flanges. Design Load is 1000 lbs. Use in pairs only		Zinc	2 pc.	BC-2786

Anchor

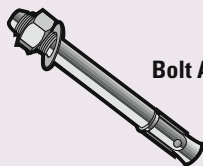
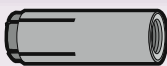

Bolt Anchor

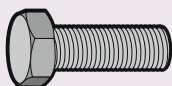

Hex Head Cap Screw
3/8" x 1"

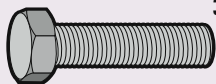

Hex Head Cap Screw
3/8" x 1-1/4"



Hex Nut



Flat Washer



Split Lock Washer

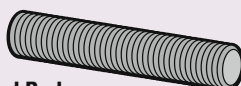

Threaded Rod

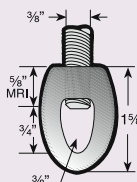

Eye Nut

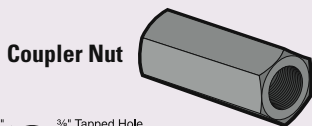

Coupler Nut

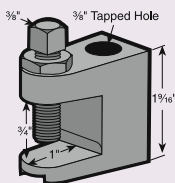

Beam Clamp

Beam Clamp

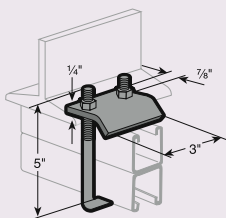

Installation Components

Bold Type Designates a Stock Item

Order by Product ID Number

DESCRIPTION	SIZE	MATERIAL	PKGD.	PRODUCT ID
Channel Nut , without spring	3/8"	Zinc	each	CHN-0380
Saddlenut Assembly <i>"Replaces Square Washer Plate and a Channel Nut Combination"</i>		Zinc	25	SN-0380
Hanger Rod Stiffener Assembly <i>"Adds Rigidity to all Threaded Rod / Strut Channel Combinations where Earthquake Activity is a Concern"</i>		Zinc	each	SA-100
Slotted Strut, 14 Gauge	13/16"(D) x 1-5/8", 10' Length	Zinc	each	UN-100
Slotted Strut, 14 Gauge <i>"An Economical Alternative When You Don't Require Our Heavy-Duty Strut (UN-202)"</i>	1-5/8"(D) x 1-5/8", 10' Length	Zinc	each	UN-201
Slotted Strut, 12 Gauge	1-5/8"(D) x 1-5/8", 10' Length	Zinc	each	UN-202
Strut, 12 Gauge	9/16" Hole Strut 1-5/8"(D) x 1-5/8", 10' Length	Zinc	each	UN-200
90° Strut Bracket	2 x 2, 9/16" Holes	Zinc	each	BRKT-0900
90° Strut Bracket	2 x 1, 9/16" Holes	Zinc	each	BRKT-0901
45° Strut Bracket	9/16" Holes	Zinc	each	BRKT-0450
Square Washer Plate	7/16" Hole for 3/8" Bolt Size	Zinc	100 pc.	SQW-0380
Tube Hanger , includes Bolt and Nut	For 1-1/2" OD Tube	Zinc	each	TH-150
Tube Hanger , includes Bolt and Nut	For 2" OD Tube	Zinc	each	TH-200
Tube Hanger , includes Bolt and Nut	For 2-1/8" and 2-1/4" OD Tube	Zinc	each	TH-212
Tube Hanger , includes Bolt and Nut	For 2-1/2" OD Tube	Zinc	each	TH-250
Tube Hanger , includes Bolt and Nut	For 3" OD Tube	Zinc	each	TH-300
Tube Hanger , includes Bolt and Nut	For 3-1/2" OD Tube	Zinc	each	TH-350
Tube Hanger , includes Bolt and Nut	For 4" OD Tube	Zinc	each	TH-400
Tube Hanger , includes Bolt and Nut	For 4-1/2" OD Tube	Zinc	each	TH-450
Tube Hanger , includes Bolt and Nut	For 5" OD Tube	Zinc	each	TH-500
Tube Hanger , includes Bolt and Nut	For 6" OD Tube	Zinc	each	TH-600
Tube Hanger , includes Bolt and Nut	For 8" OD Tube	Zinc	each	TH-800
Tube Hanger , includes Bolt and Nut	For 10" OD Tube	Zinc	each	TH-1000
Tube Hanger , includes Bolt and Nut	For 12" OD Tube	Zinc	each	TH-1200
Tube Hanger , includes Bolt and Nut	For 14" OD Tube	Zinc	each	TH-1400

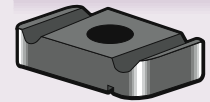

Channel Nut

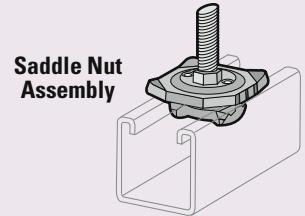

Saddle Nut Assembly

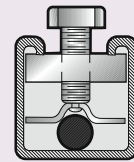

Hanger Rod Stiffener Assembly

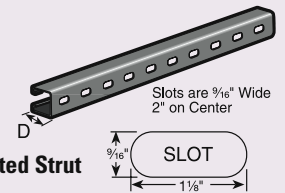

Slotted Strut

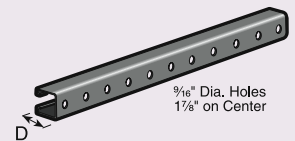

Strut

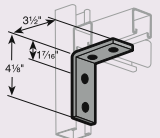

90° Strut Bracket
2 holes x 2 holes

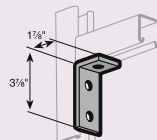

90° Strut Bracket
2 holes x 1 hole

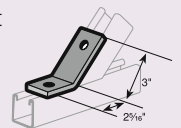

45° Strut Bracket

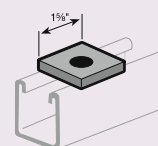

Square Washer Plate

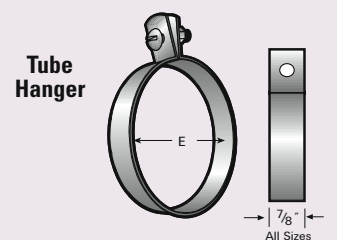

Tube Hanger

Installation Components

Bold Type Designates a Stock Item

Order by Product ID Number

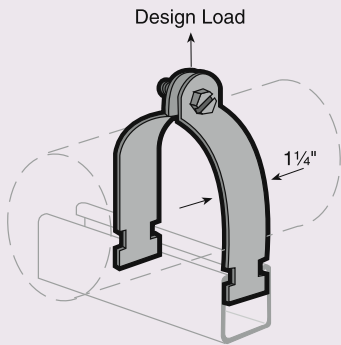

Tube/Pipe Clamp

DESCRIPTION	SIZE	MATERIAL	PKGD.	PRODUCT ID
Pipe Clamp , includes Slotted Hex Head Screw and Nut, Design Load 800 lbs.	For 1-1/2" Pipe Size	Zinc	4 pc.	PCL-150
Pipe Clamp , includes Slotted Hex Head Screw and Nut, Design Load 800 lbs.	For 2" Pipe Size	Zinc	4 pc.	PCL-200
Pipe Clamp , includes Slotted Hex Head Screw and Nut, Design Load 800 lbs.	For 2-1/2" Pipe Size	Zinc	4 pc.	PCL-250
Pipe Clamp , includes Slotted Hex Head Screw and Nut, Design Load 800 lbs.	For 3" Pipe Size	Zinc	4 pc.	TCL-350*
Pipe Clamp , includes Slotted Hex Head Screw and Nut, Design Load 1000 lbs.	For 3-1/2" Pipe Size	Zinc	4 pc.	TCL-400*
Pipe Clamp , includes Slotted Hex Head Screw and Nut, Design Load 1000 lbs.	For 4" Pipe Size	Zinc	4 pc.	TCL-450*
Pipe Clamp , includes Slotted Hex Head Screw and Nut, Design Load 1000 lbs.	For 5" Pipe Size	Zinc	4 pc.	PCL-500
Pipe Clamp , includes Slotted Hex Head Screw and Nut, Design Load 1000 lbs.	For 6" Pipe Size	Zinc	4 pc.	PCL-600
Pipe Clamp , includes Slotted Hex Head Screw and Nut, Design Load 1000 lbs.	For 8" Pipe Size	Zinc	4 pc.	PCL-800**
* Tube Clamp also fits this pipe size.				
** 2 piece package				
Tube Clamp , includes Slotted Hex Head Screw and Nut, Design Load 600 lbs.	For 1-1/2" OD Tube	Zinc	4 pc.	TCL-150
Tube Clamp , includes Slotted Hex Head Screw and Nut, Design Load 800 lbs.	For 2" OD Tube	Zinc	4 pc.	TCL-200
Tube Clamp , includes Slotted Hex Head Screw and Nut, Design Load 800 lbs.	For 2-1/8" OD Tube	Zinc	4 pc.	TCL-212
Tube Clamp , includes Slotted Hex Head Screw and Nut, Design Load 800 lbs.	For 2-1/2" OD Tube	Zinc	4 pc.	TCL-250
Tube Clamp , includes Slotted Hex Head Screw and Nut, Design Load 800 lbs.	For 3" OD Tube	Zinc	4 pc.	TCL-300
Tube Clamp , includes Slotted Hex Head Screw and Nut, Design Load 800 lbs.	For 3-1/2" OD Tube	Zinc	4 pc.	TCL-350
Tube Clamp , includes Slotted Hex Head Screw and Nut, Design Load 1000 lbs.	For 4" OD Tube	Zinc	4 pc.	TCL-400
Tube Clamp , includes Slotted Hex Head Screw and Nut, Design Load 1000 lbs.	For 4-1/2" OD Tube	Zinc	4 pc.	TCL-450
Tube Clamp , includes Slotted Hex Head Screw and Nut, Design Load 1000 lbs.	For 5" OD Tube	Zinc	4 pc.	TCL-500
Tube Clamp , includes Slotted Hex Head Screw and Nut, Design Load 1000 lbs.	For 6" OD Tube	Zinc	4 pc.	TCL-600
Tube Clamp , includes Slotted Hex Head Screw and Nut, Design Load 1000 lbs.	For 8" OD Tube	Zinc	4 pc.	TCL-800**
** 2 piece package				



Installation Components

Bold Type Designates a Stock Item

Order by Product ID Number

DESCRIPTION	SIZE	MATERIAL	PKGD.	PRODUCT ID
Cable Tie Features: One-piece construction. Easy to use. Permanent lock. Designed to withstand 90 lbs. of force. Richco Brand.	23" Length	Nylon	100 pc.	TIE-100
Cable Tie Features: One-piece construction. Easy to use. Permanent lock. Designed to withstand 60 lbs. of force. Catamount Brand. <i>"When Our Heavy-Duty Cable Tie (TIE-100) Isn't Necessary"</i>	24" Length	Nylon	50 pc.	TIE-101
Cable Tie Features: One-piece construction. Easy to use. Permanent lock. Designed to withstand 25 lbs. of force. Catamount Brand. <i>"A Light-Duty, Shorter Length Tie"</i>	14" Length	Nylon	100 pc.	TIE-200

Firestop Sealant 4-gallon Bucket - each FSB-100

A non-sag silicone which remains flexible after curing for simple metal pipe penetrations and fire-rated joints where the ability to absorb movement and/or vibration is required.

Features: Just 1/4" layer provides up to a 3-hour fire rating when backed with 4" of mineral wool. Superior adhesion characteristics. Resistant to smoke and water. Excellent elongation/compression properties. Distributed by Hilti®.

Firestop Sealant 10.5-oz. Tube - each **FST-100**

Metal Sealant Quart Can - each **2084-QT**

An aluminum-colored, medium viscosity, synthetic rubber sealant with excellent adhesion to many metal, glass, wood and other surfaces.

Features: Adheres to metal, wood and glass. Seals metal to glass in windows and doors. Resists weather, water, oil and gasoline. Solids wt. approx. 46%, Flash Point (closed cup) 0° F, heavy liquid consistency, aluminum color (dry), brush or flow application. Drying time is 24 hours (1/8" dia. bead), service temp. range of -30° to 200° F. 3M Scotch-Seal™ 2084 Metal Sealant repackaged by H-P Products, Inc.

Cable Ties

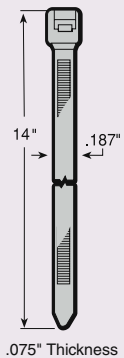
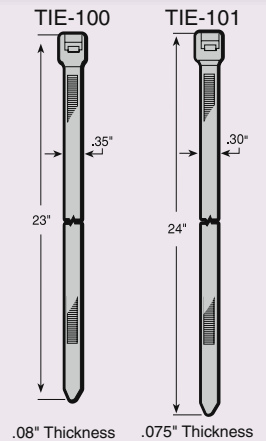

Firestop Sealant



Metal Sealant

"Surface dries tack-free in approx. 5 min."